

# Edinburgh Mathematical Society.

---

## LIST OF MEMBERS.

---

TWENTY-THIRD SESSION 1904-1905.

---

- 1 V. RAMASWAMI AIYAR, M.A., Deputy Collector, Arni, India.  
ROBERT J. ALEY, Professor of Mathematics, Indiana University,  
Bloomington, Indiana, U.S.A.  
JOHN ALISON, M.A., F.R.S.E., Headmaster, George Watson's  
College, Edinburgh.  
R. E. ALLARDICE, M.A., Professor of Mathematics, Leland-  
Stanford Junior University, Palo Alto, California.
- 5 ERNEST M. ANDERSON, M.A., B.Sc., 65 Warrender Park Road,  
Edinburgh.  
JOHN ANDERSON, M.A., B.Sc., Eskbank, Dalkeith.  
WM. ANDERSON, M.A., F.R.S.E., George Watson's College,  
Edinburgh.  
JAMES ARCHIBALD, M.A., 52 Polwarth Gardens, Edinburgh  
(*Honorary Treasurer*).  
LOUDON ARNEIL, M.A., U.F. Training College, Glasgow.
- 10 PAUL AUBERT, Professeur au Lycée Charlemagne, Paris.  
A. J. GUNION BARCLAY, M.A., F.R.S.E., High School, Glasgow.  
E. P. BARRETT, B.A., B.Sc., Foyle College, Londonderry.  
J. C. BEATTIE, D.Sc., F.R.S.E., Professor of Applied Mathe-  
matics and Experimental Physics, South African College,  
Cape Town.  
ROBT. J. T. BELL, M.A., B.Sc., 90 Barrington Drive, Glasgow.
- 15 PETER BENNETT, Glasgow and West of Scotland Technical  
College, Glasgow.  
EDWARD BLADES, M.A., B.Sc., George Watson's Ladies' College,  
Edinburgh.  
JAMES BOLAM, Leith Nautical College, Leith.  
Professor T. J. I'A BROMWICH, M.A., Queen's College, Galway.

- A. BROWN, M.A., B.Sc., Professor of Applied Mathematics, South African College, Capetown.
- 20 H. H. BROWNING, M.A., 128 Byres' Road, Glasgow.  
J. BRUCE-KINGSMILL, R.A., Compton Mount, Compton, Winchester.
- JAMES BUCHANAN, M.A., 9 St Andrew Square, Edinburgh.  
A. G. BURGESS, M.A., F.R.S.E., Ladies' College, Queen Street, Edinburgh.
- J. W. BUTTERS, M.A., B.Sc., F.R.S.E., Rector, The Academy, Ardrossan.
- 25 JOHN F. CAMERON, M.A., Fellow and Tutor of Caius College, Cambridge.  
GEORGE A. CARSE, M.A., B.Sc., Emmanuel College, Cambridge.  
HORATIO S. CARSLAW, M.A., D.Sc., F.R.S.E., University, Sydney, Australia.  
CHARLES CHREE, M.A., D.Sc., F.R.S., 25 Mount Ararat Road, Richmond, Surrey.  
GEORGE CHRYSAL, M.A., LL.D., Sec. R.S.E., Professor of Mathematics, University, Edinburgh (*Hon. Member*).
- 30 J. B. CLARK, M.A., F.R.S.E., George Heriot's School, Edinburgh.  
PETER COMRIE, M.A., B.Sc., Boroughmuir School, Edinburgh.  
G. E. CRAWFORD, M.A., Wykeham House, Manilla Road, Clifton, Bristol.  
LAWRENCE CRAWFORD, M.A., D.Sc., Professor of Mathematics, South African College, Cape Town.  
R. F. DAVIS, M.A., 12 Rusthall Avenue, Acton Green, London, W.
- 35 J. MACALISTER DODDS, M.A., Peterhouse, Cambridge.  
A. C. DIXON, M.A., F.R.S., Professor of Mathematics, Queen's College, Belfast.  
J. A. DOIG, George Watson's College, Edinburgh.  
A. GRAHAM DONALD, M.A., F.F.A., Scottish Provident Institution, Edinburgh.  
CHAS. S. DOUGALL, M.A., Rector, The Institution, Dollar.
- 40 JOHN DOUGALL, M.A., Kippen, Stirlingshire.  
ALBERT DRIVER, George Watson's College, Edinburgh.  
DAVID DRYSDALE, M.A., Royal Academy, Irvine.  
JOHN G. DUNBAR, M.A., B.Sc., The Academy, Ardrossan.  
GEORGE DUTHIE, M.A., B.A., F.R.S.E., Superintending Inspector of Schools and Statist, Salisbury, Rhodesia.
- 45 JAMSHEDJ EDALJI, Professor, Gujarat College, Ahmedabad, India.  
GEORGE EDNIE, M.A., B.Sc., The Academy, Dumfries.  
JAS. M. EDWARD, M.A., Headmaster, Wigtown.

- JOHN EDWARDS, M.A., The Academy, Ardrossan.  
 JAS. ERSKINE-MURRAY, D.Sc., 2 Crown Gardens, Glasgow.
- 50 R. M. FERGUSON, Ph.D., LL.D., F.R.S.E., 5 Douglas Gardens, Edinburgh.  
 JAMES FINDLAY, 11 Morningside Gardens, Edinburgh.  
 Rev. NORMAN FRASER, B.D., 84 Craiglea Drive, Edinburgh.  
 WM. GENTLE, B.Sc., George Heriot's School, Edinburgh.  
 H. T. GERRANS, M.A., Fellow and Tutor of Worcester College, Oxford.
- 55 GEORGE A. GIBSON, M.A., LL.D., Professor of Mathematics, West of Scotland Technical College, Glasgow (*Hon. Member*).  
 JAMES GOODWILLIE, M.A., B.Sc., Lecturer on Mathematics, King's College, Aberdeen.  
 GEORGE GREEN, M.A., 3 Edgefauld Terrace, Springburn, Glasgow.  
 W. J. GREENSTREET, M.A., Headmaster, Marling School, Stroud.  
 P. S. HARDIE, M.A., B.Sc., Ras-el-Tin Government School, Alexandria, Egypt.
- 60 R. P. HARDIE, M.A., Assistant to the Professor of Logic, University, Edinburgh.  
 E. W. HERBERT, M.A., The Academy, Edinburgh.  
 WM. HISLOP, M.A., Academy, Rothesay.  
 ALEX. HOLM, M.A., Girls' High School, Glasgow.  
 JAMES HORNE, George Watson's College, Edinburgh.
- 65 W. R. HUGHES, B.A., Fellow of Jesus College, Cambridge.  
 PETER D. INNES, M.A., B.Sc., 16 Argyle Place, Edinburgh.  
 JOHN JACK, M.A., Professor of Mathematics, Wilson College, Bombay.  
 W. JACK, M.A., LL.D., Professor of Mathematics, University, Glasgow (*Hon. Member*).  
 Rev. FRANK H. JACKSON, M.A., R.N., Chaplain and Naval Instructor, H.M.S. "Acheron," Chatham.
- 70 JOHN JEFFREY, M.A., B.Sc., Rector, High School, Selkirk.  
 WM. JEFFREY, M.A., Academy, Banff.  
 GEORGE JOHNSTON, M.A., Spier's School, Beith.  
 D. M. JOHNSTONE, M.A., B.Sc., George Heriot's School, Edinburgh.  
 LORD KELVIN, LL.D., D.C.L., F.R.S., F.R.S.E., etc., Glasgow (*Hon. Member*).
- 75 JOHN W. KIPPEN, Headmaster, St Andrew's School, Dundee.  
 CARGILL G. KNOTT, D.Sc., F.R.S.E., Lecturer on Applied Mathematics, University, Edinburgh.

- ARCHIBALD LANG, M.A., Provanside School, Glasgow.  
 P. R. SCOTT LANG, M.A., B.Sc., F.R.S.E., Professor of Mathematics, University, St Andrews.  
 W. S. LAURIE, M.A., Mathematical Master, High School, Kelso.
- 80 GEORGE LAWSON, M.A., Rector, Waid Academy, Anstruther.  
 R. LEES, M.A., B.Sc., Headmaster, The Academy, Fraserburgh.  
 ALEXANDER LEIGHTON, M.A., B.Sc., Morgan Academy, Dundee.  
 WM. A. LINDSAY, M.A., B.Sc., U.F. Church Training College, Glasgow (*Co. Editor of Proceedings*).  
 JAMES LITTLEJOHN, M.A., 11 Kinnaird Street, Arbroath.
- 85 ALEX. V. LOTHIAN, M.A., B.Sc., F.R.S.E., Mathematical and Science Lecturer, E.C. Training College, Glasgow.  
 J. BARRIE-LOW, M.A., Wrenschtown House, Observatory Road, Cape Town.  
 WM. H. LOVE, M.A., U.F. Training College, Glasgow.  
 E. O. LOVETT, Professor of Mathematics, Princeton University, New Jersey, U.S.A.  
 JOHN H. M'ALPINE, M.I.N.A., 615 Walnut Street, Philadelphia.
- 90 JAMES A. M'BRIDE, B.A., B.Sc., Allan Glen's School, Glasgow.  
 JAS. M'CUBBIN, B.A., F.R.S.E., Rector, The Academy, Kilsyth.  
 JAMES A. MACDONALD, M.A. B.Sc., F.R.S.E., H.M.I.S., Dingwall, N.B.  
 J. A. MACDONALD, M.A., B.Sc., George Watson's Ladies' College, Edinburgh.  
 W. J. MACDONALD, M.A., F.R.S.E., Daniel Stewart's College, The Dean, Edinburgh.
- 95 D. C. M'INTOSH, M.A., F.R.S.E., Ladies' College, Queen Street, Edinburgh (*Vice-President*).  
 ALEX. C. MACKAY, M.A., B.Sc., Rector, High School, Falkirk.  
 J.S. MACKAY, M.A., LL.D., F.R.S.E., 69 Northumberland Street, Edinburgh (*Hon. Member*).  
 Rev. JOHN MACKENZIE, M.A., Professor, U.F.C. College, Madras.  
 ANGUS M'LEAN, B.Sc., C.E., Principal, Technical College, Paisley.
- 100 PETER M'LEOD, M.A., B.Sc., Hillhead High School, Glasgow.  
 DONALD MACMILLAN, M.A., Clifton Bank School, St Andrews.  
 JESSIE CHRYSAL MACMILLAN, M.A., B.Sc., Corstorphine Hill House, Edinburgh.  
 D. S. M'NAIR, B.Sc., Ph.D., H.M.I.S., Edinburgh.  
 C. E. M'VICKER, M.A., 5 Comely Bank, Edinburgh.
- 105 A. J. MARTIN, M.A., B.Sc., Spier's School, Beith.  
 ARTEMAS MARTIN, M.A., Ph.D., LL.D., U.S. Coast Survey Office, Washington, D.C., U.S.A.

- J. B. MEIKLEJOHN, M.A., High School, Dundee.
- JOAQUIN DE MENDIZABAL Y TAMBORREL, Professor de Mathématique, Palma, 13 Mexico.
- ALEX. T. MERRILEES, M.A., 12 Marchmont Street, Edinburgh.
- 110 W. J. MILLAR, C.E., late Secretary, Instit. Engineers and Ship-builders in Scotland, 31 Marine Place, Rothesay.
- JOHN MILLER, M.A., West of Scotland Technical College, Glasgow.
- T. HUGH MILLER, M.A., D.Sc., Training College, Isleworth, near London.
- WILLIAM MILLER, M.A., 48 Windsor Terrace, St George's Road, Glasgow.
- ARCH. MILNE, M.A., B.Sc., E.C. Training College, Edinburgh.
- 115 HUGH MITCHELL, High Losset Farm, Machrihanish.
- JAMES MITCHELL, M.A., B.Sc., 7 Bath Street, Nairn.
- GEORGE L. MOFFAT, M.A., B.Sc., The Academy, Glasgow.
- ALEXANDER MORGAN, M.A., D.Sc., F.R.S.E., Principal, Church of Scotland Training College, Edinburgh.
- J. T. MORRISON, M.A., B.Sc., F.R.S.E., Professor of Physics, Stellenbosch, Cape Colony.
- 120 THOMAS MUIR, M.A., LL.D., F.R.S., F.R.S.E., C.M.G., Superintendent-General of Education, Mowbray Hall, Rosebank, Cape Colony.
- R. FRANKLIN MUIRHEAD, M.A., D.Sc., 24 Kersland Street, Hillhead, Glasgow.
- ASUTOSH MUKHOPADHYAY, M.A., LL.D., F.R.A.S., F.R.S.E., Professor of Mathematics, Bhowanipore, Calcutta.
- DAVID MURRAY, M.A., B.Sc., Rector, The Academy, Kilmarnock.
- A. M. C. MUTCH, M.A., B.Sc., Royal Academical Institution, Belfast.
- 125 R. J. NICHOLSON, M.A., B.Sc., George Watson's College, Edinburgh.
- CHARLES NIVEN, M.A., D.Sc., F.R.S., Professor of Natural Philosophy, University, Aberdeen (*Hon. Member*).
- THOMAS NIBBET, M.A., 4 Nisbet Street, Parkhead, Glasgow.
- A. S. OGILVIE, M.A., B.Sc., E.C. Training College, Edinburgh.
- R. T. OMOND, F.R.S.E., 3 Church Hill, Edinburgh.
- 130 W. M'F. ORR, M.A., Professor of Mathematics, Royal College of Science, Dublin.
- L. F. OTTO, M.A., 12 Canning Road, Allahabad, India.
- JOHN T. PEARCE, B.A., Science College, Leith.
- FRANK PEARSON, M.A., George Watson's College, Edinburgh.
- J. PECK, M.A., F.R.S.E., H.M.I.S., 22 Duke Street, Edinburgh.

- 135 WILLIAM PEDDIE, D.Sc., F.R.S.E., Lecturer on Natural Philosophy, University, Edinburgh.  
 GEORGE PHILIP, M.A., B.Sc., The Academy, Glasgow.  
 WM. EDWARD PHILIP, M.A., H.M.I.S., Aberdeen.  
 ROBERT PHILP, M.A., Hutcheson's Grammar School, Glasgow.  
 D. K. PICKEN, M.A., Lecturer and Assistant Professor, University, Glasgow.
- 140 P. PINKERTON, M.A., F.R.S.E., George Watson's College, Edinburgh (*Hon. Secretary*).  
 R. H. PINKERTON, M.A., University College, Cardiff.  
 A. J. PRESSLAND, M.A., F.R.S.E., The Academy, Edinburgh.  
 HARRY RAINY, M.A., M.D., F.R.S.E., 16 Great Stuart Street, Edinburgh.  
 PETER RAMSAY, M.A., B.Sc., Allan Glen's School, Glasgow.
- 145 THOS. T. RANKINE, C.E., B.Sc., Principal, Wigan and District Mining and Technical College, Wigan.  
 DAVID RENNETT, LL.D., 32 Fountainhall Road, Aberdeen.  
 A. J. ROSS, M.A., B.Sc., Gillespie's School, Edinburgh.  
 EDWARD B. ROSS, M.A., 5 Viewforth Square, Edinburgh.  
 PETER ROSS, M.A., B.Sc., Broughton School, Edinburgh.
- 150 ALEX. ROUTLEDGE, B.A., 32 Clonmore Road, N. Strand, Dublin.  
 ALEX. D. RUSSELL, B.Sc., High School, Falkirk.  
 CHARLOTTE ANGAS SCOTT, D.Sc., Professor of Mathematics, Bryn Mawr College, Pennsylvania, U.S.A.  
 R. F. SCOTT, M.A., St John's College, Cambridge.  
 W. SCRIMGEOUR, M.A., B.Sc., 8 Bath Place, Ayr.
- 155 RODERICK M. SHEARER, M.A., B.Sc., 30 Blackwood Crescent, Edinburgh.  
 EDWARD SMART, B.A., B.Sc., The Academy, Perth.  
 DUNCAN Y. M. SOMERVILLE, M.A., B.Sc., Lecturer in Applied Mathematics, University of St Andrews.  
 FRANK SPENCE, M.A., B.Sc., F.R.S.E., U.F. Church Training College, Edinburgh.  
 T. B. SPRAGUE, M.A., LL.D., F.R.S.E., 29 Buckingham Terrace, Edinburgh.
- 160 J. E. A. STEGGALL, M.A., Professor of Mathematics, University College, Dundee.  
 ALEX. STEVENSON, M.A., B.Sc., Whitehill School, Glasgow.  
 H. F. THOMPSON, B.A., Academy, Edinburgh.  
 AMY TREVOR STEELE, M.A., George Watson's Ladies' College, Edinburgh.

- ADAM B. STEWART, M.A., School of Agriculture, Ghizeh, Cairo, Egypt.
- 165 LOUISA STORY, George Watson's Ladies' College, Edinburgh,  
WALTER STOTT, Hon. Sec., Liverpool Mathematical Society,  
4 Grasmere Drive, Liscard.  
JOHN G. SUTHERLAND, M.A., The Academy, Greenock.  
DAVID G. TAYLOR, M.A., University College, Cardiff.  
JAMES TAYLOR, M.A., F.R.S.E., The Academy, Edinburgh.
- 170 W. S. TEMPLETON, M.A., B.Sc., Royal Indian Engineering  
College, Cooper's Hill, Englefield Green, Surrey.  
J. A. THIRD, M.A., D.Sc., Spier's School, Beith.  
W. L. THOMPSON, M.A., B.Sc., Allan Glen's School, Glasgow.  
ANDREW THOMSON, M.A., D.Sc., F.R.S.E., The Academy, Perth.  
WM. THOMSON, M.A., B.Sc., LL.D., F.R.S.E., Registrar to the  
Cape University, Cape Colony.
- 175 W. L. THOMSON, M.A., George Heriot's School, Edinburgh  
(*President*).  
JOHN TURNER, M.A., B.Sc., Royal High School, Edinburgh  
(*Co-Editor of Proceedings*).  
CHARLES TWEEDIE, M.A., B.Sc., F.R.S.E., Lecturer on Mathe-  
matics, University, Edinburgh.  
DAVID TWEEDIE, M.A., B.Sc., Ministry of Public Instruction,  
Cairo, Egypt.  
GEORGE D. VALENTINE, M.A., Advocate, 13 Pitt Street,  
Edinburgh.
- 180 SAMUEL WALKER, M.A., D.Sc., George Heriot's School, Edin-  
burgh.  
A. G. WALLACE, M.A., F.R.S.E., Headmaster, Central Public  
School, Aberdeen.  
W. WALLACE, M.A., F.R.S.E., Principal, Cockburn Science  
School, Leeds.  
W. G. WALTON, F.F.A., Scottish Provident Office, 6 St Andrew  
Square, Edinburgh.  
JOHN C. WATT, M.A., Jesus College, Cambridge.
- 185 JAMES MACPHERSON WATTIE, M.A., B.A., H.M.I.S., Linton,  
Strathern Road, Broughty-Ferry.  
J. H. MACLAGAN WEDDERBURN, M.A., University, Edinburgh.  
JOHN WEIR, M.A., Professor of Mathematics, Mysore, India.  
WILLIAM WELSH, M.A., Jesus College, Cambridge.  
JOHN W. WHITE, Lorne Street Public School, Leith.
- 190 WM. WYPER, C.E., 10 Highbury Terrace, Dowanhill, Glasgow.  
W. YOUNG, F.F.A., Fidelity Mutual Insurance Company,  
112-116 North Broad Street, Philadelphia, Pa, U.S.A.

*The following Presents to the Library have been received, for which the Society tenders its grateful thanks.*

---

1. Proceedings of the London Mathematical Society.
2. Memoirs and Proceedings of the Manchester Literary and Philosophical Society.
3. Proceedings of the Cambridge Philosophical Society.
4. Bulletin of the American Mathematical Society.
5. Transactions of the American Mathematical Society.
6. Annals of Mathematics. Published under the auspices of the University of Virginia.
7. Proceedings of the American Philosophical Society (Philadelphia).
8. Mathematical Gazette.
9. Annales de la Faculté des Sciences de Marseille.
10. Bulletin de la Société Mathématique de France.
11. Journal de Mathématiques Élémentaires.  
Publié par M. H. VUIBERT.
12. Communications de la Société Mathématique de Kharkow.
13. Mathematisch-naturwissenschaftliche Mitteilungen im Auftrag des mathematisch-naturwissenschaftliche Vereins in Württemberg.
14. Revue Semestrielle des Publications Mathématiques. Published under the auspices of the Mathematical Society of Amsterdam.
15. Mémoires de la Société Royale des Sciences de Liège.
16. Tōkyō Sūgaku-Buturigaku Kwai Kizi.
17. Jornal de Sciencias Mathematicas e Astronomicas.  
Publicado pelo Dr F. GOMES TELXEIRA.
18. Rendiconti del Circolo Mathematico di Palermo.
19. Wiskundige Opgaven met de Oplossingen.
20. Revue de mathématiques publiée par G. PEANO.
21. Bulletin de la Société Physico-Mathématique de Kasan.



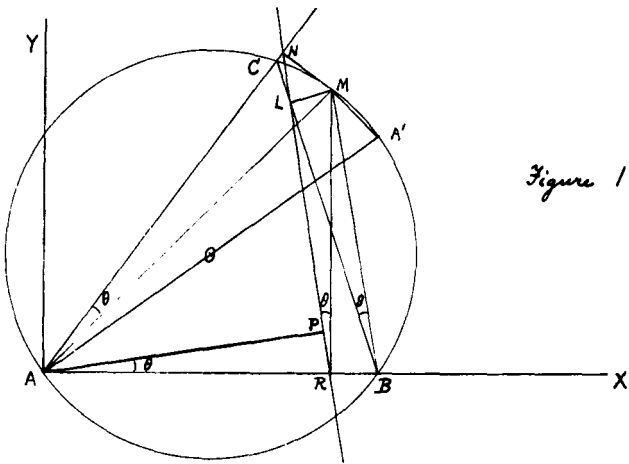


Figure 1

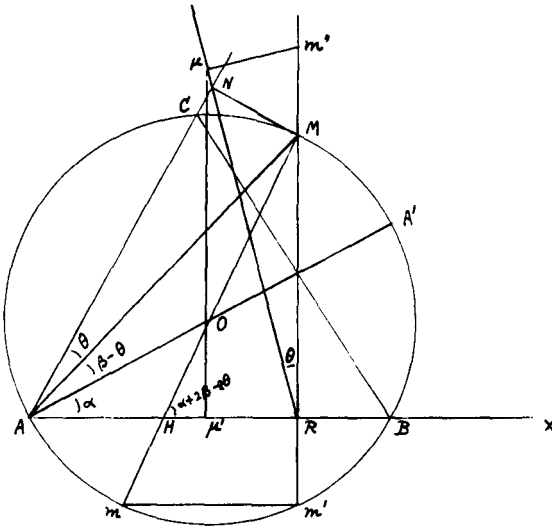


Figure 2

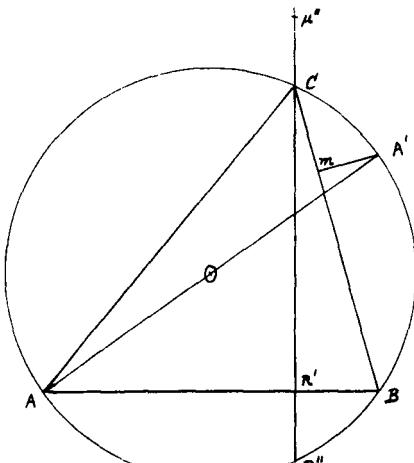


Figure 3

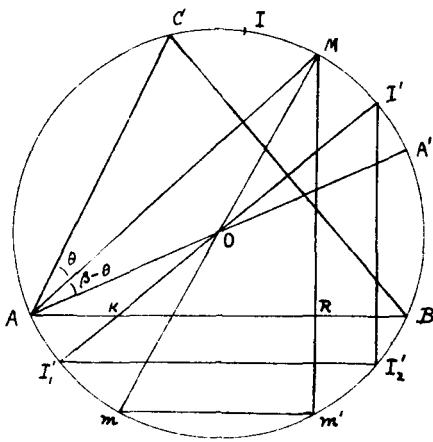


Figure 4

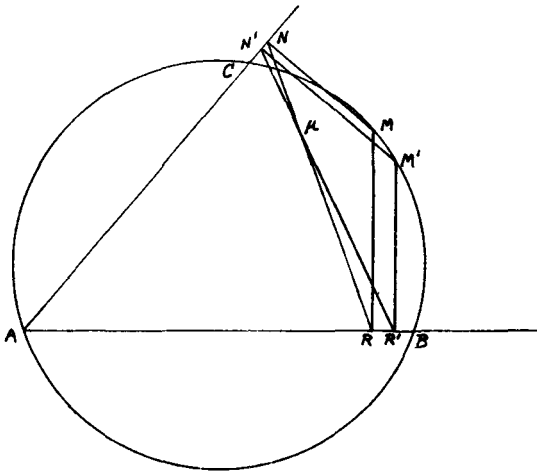


Figure 5

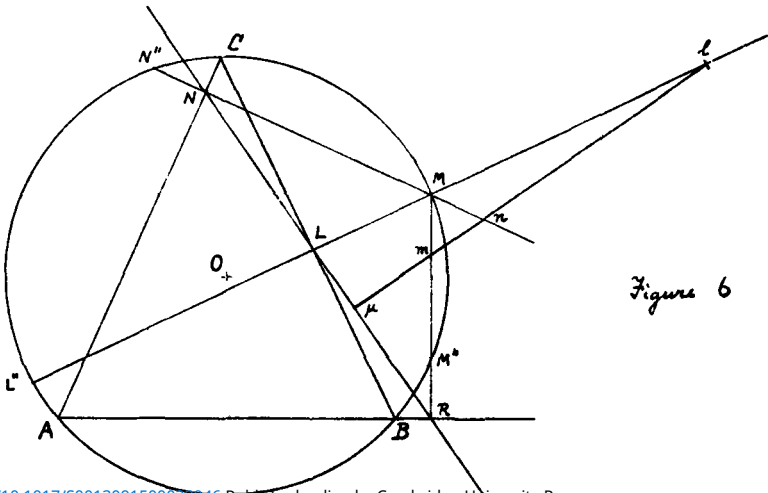


Figure 6

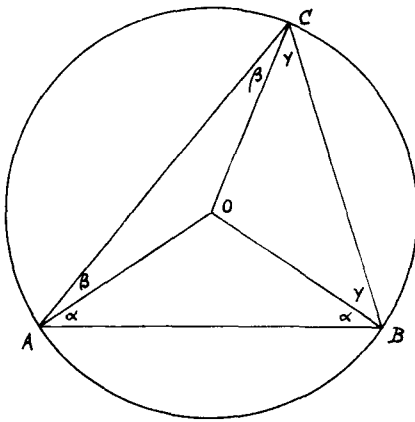


Figure 7

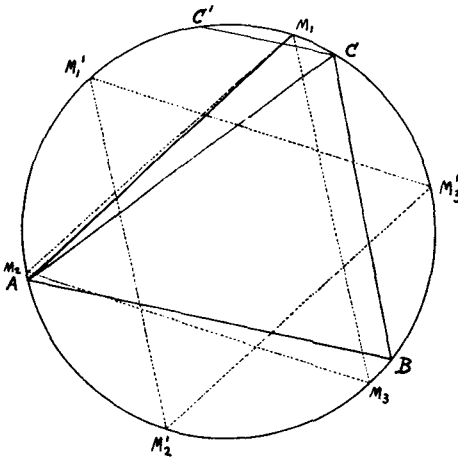


Figure 8

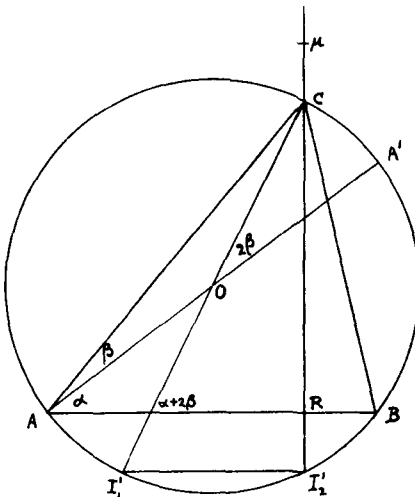


Figure 9

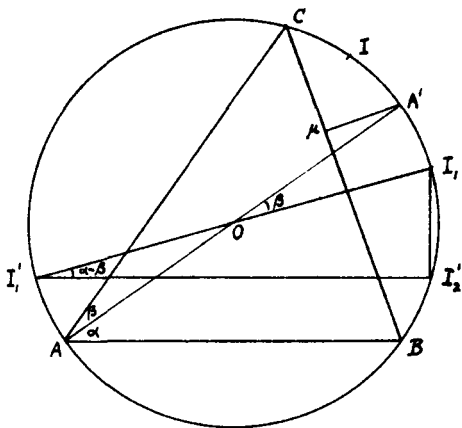


Figure 10

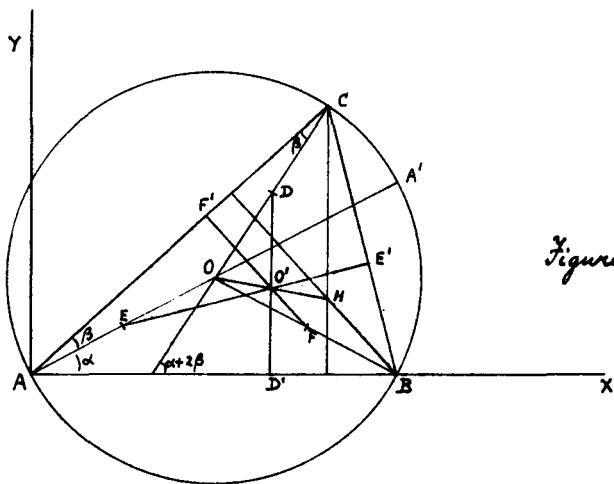


Figure 11

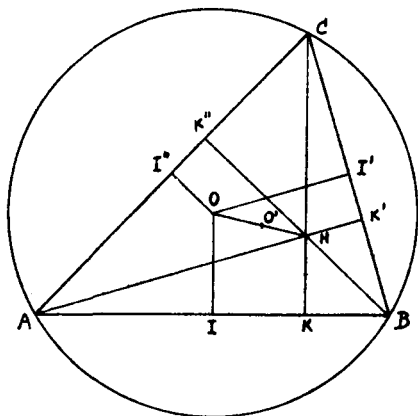


Figure 12

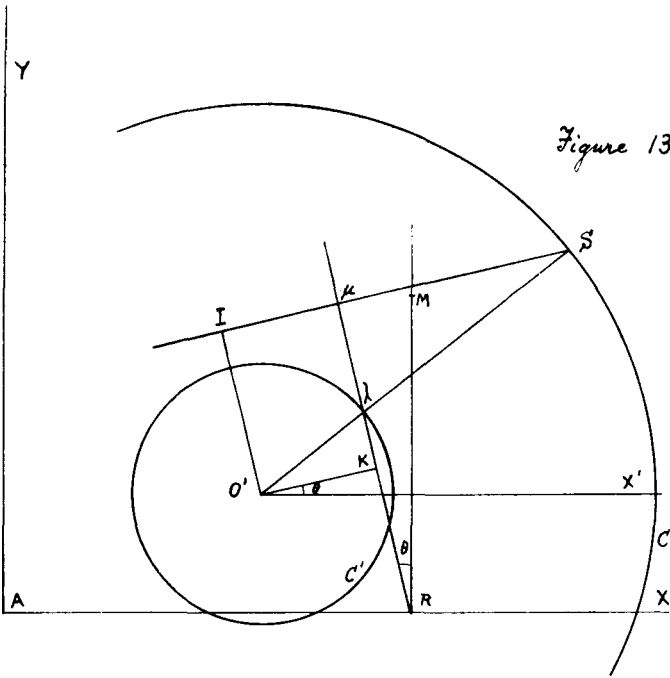


Figure 13

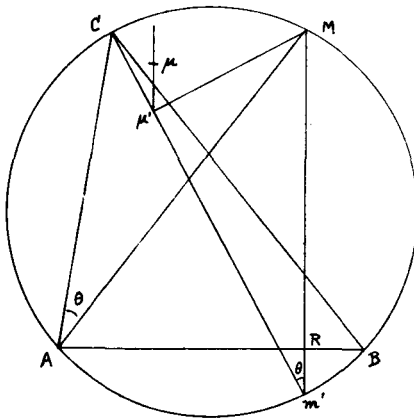


Figure 14

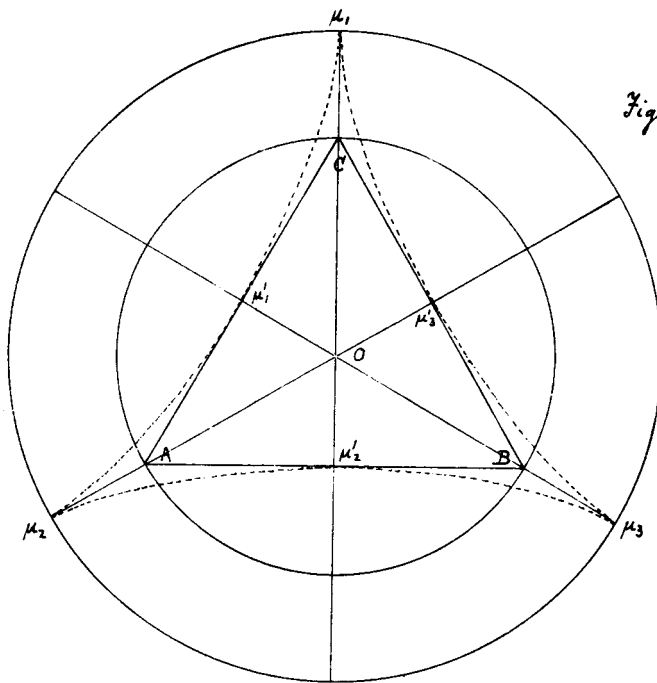


Figure 15

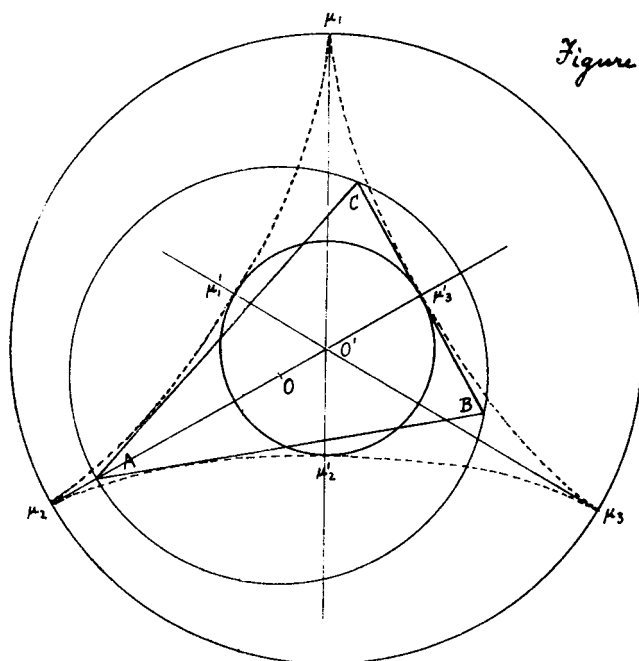


Figure 16

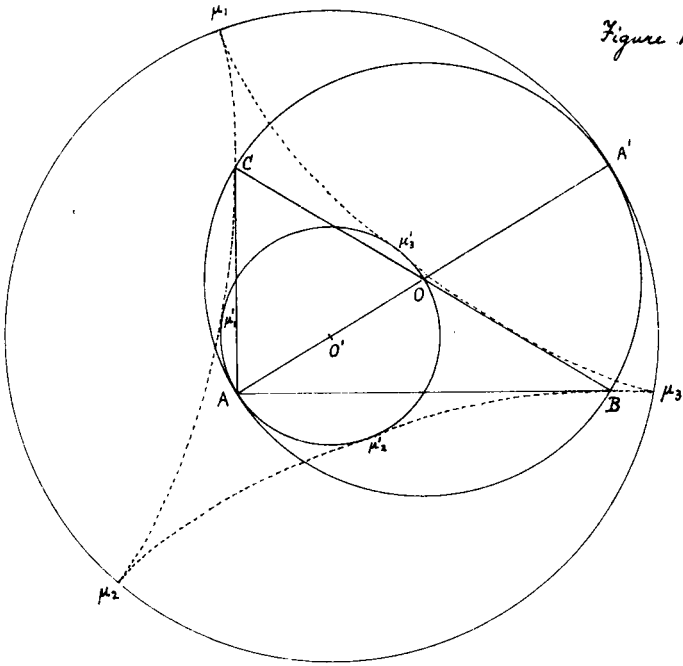


Figure 17

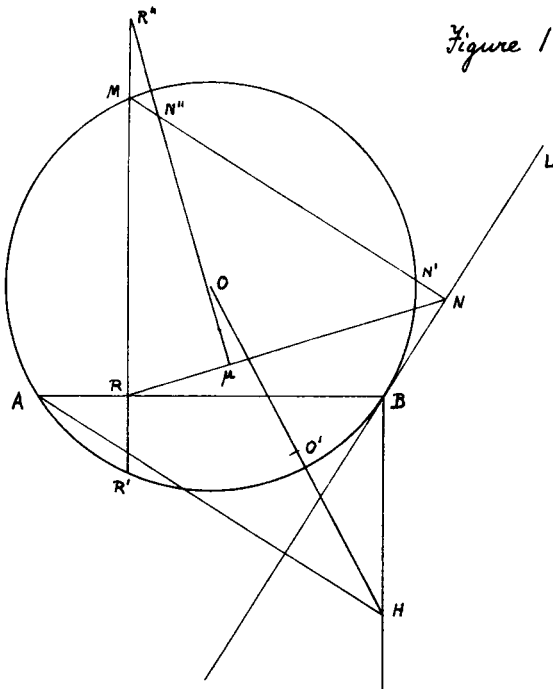


Figure 18

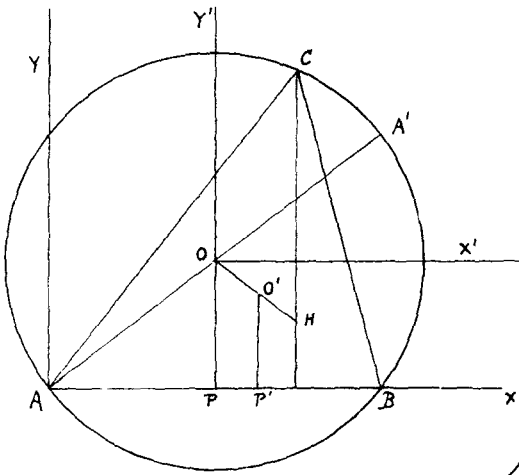


Figure 19

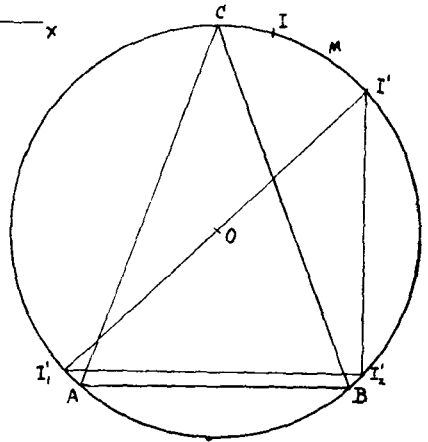


Figure 20

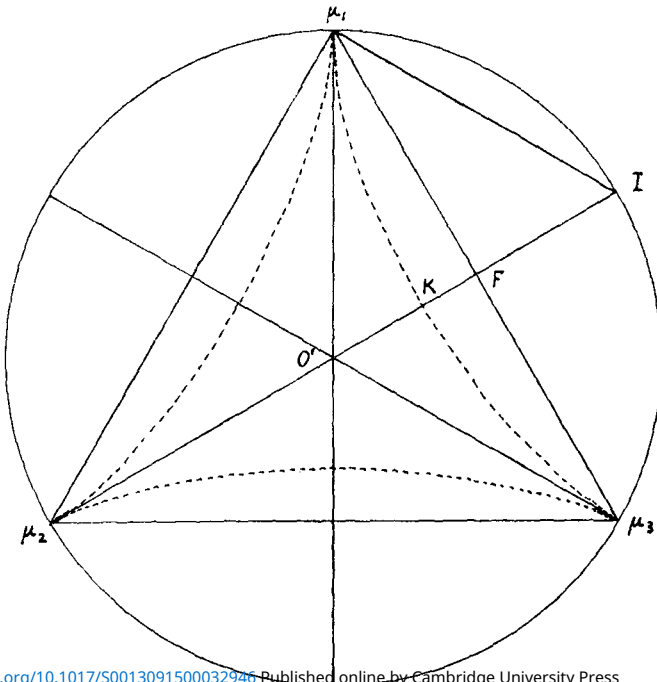


Figure 21



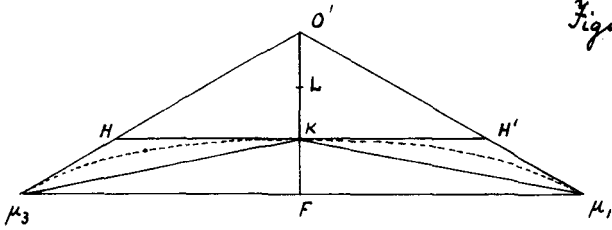


Figure 22

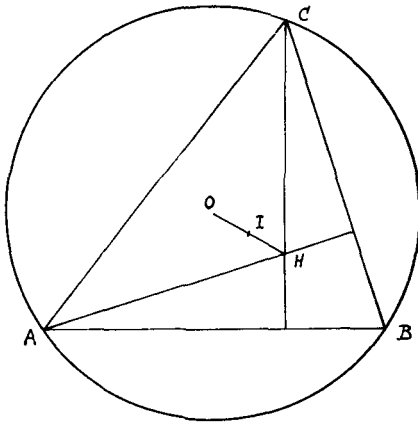


Figure 23

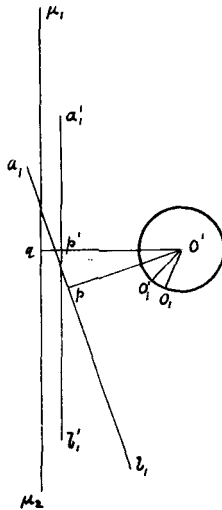


Figure 24

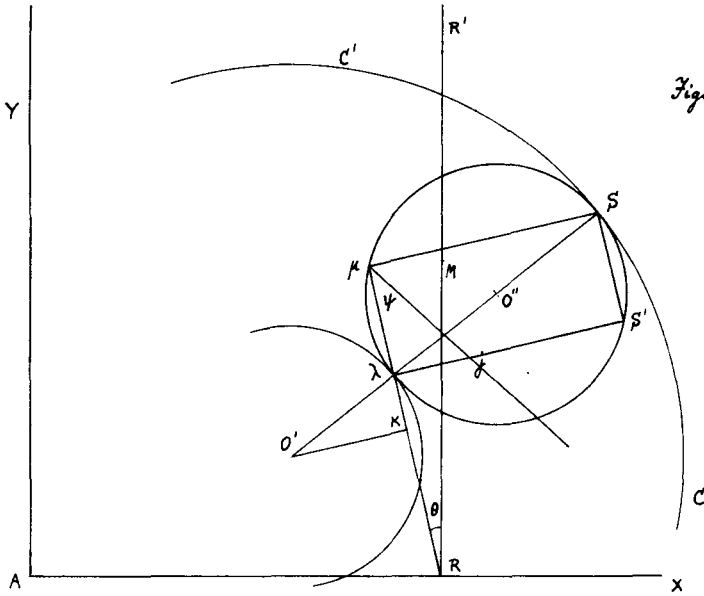


Figure 25

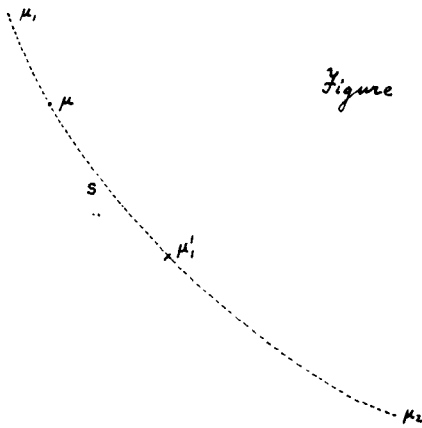
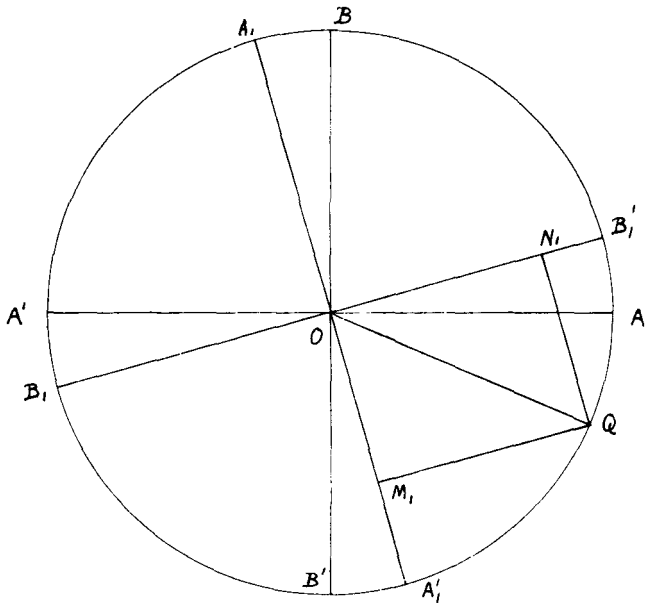
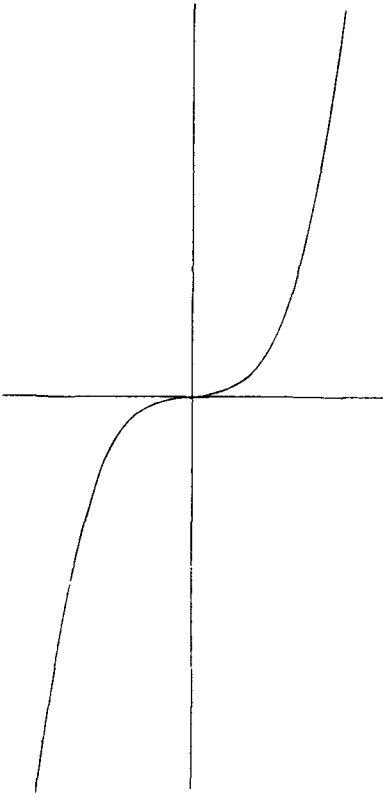


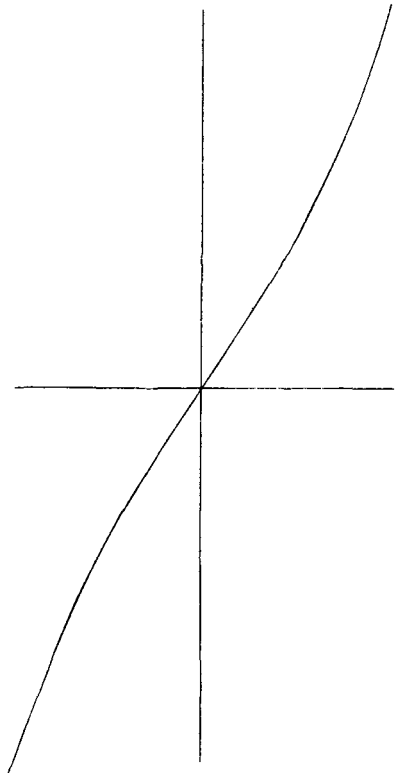
Figure 26

Figure 27

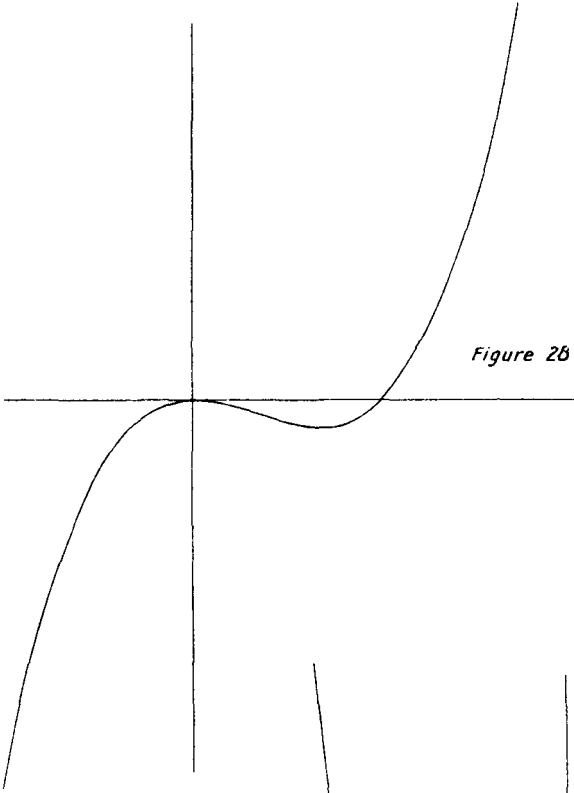




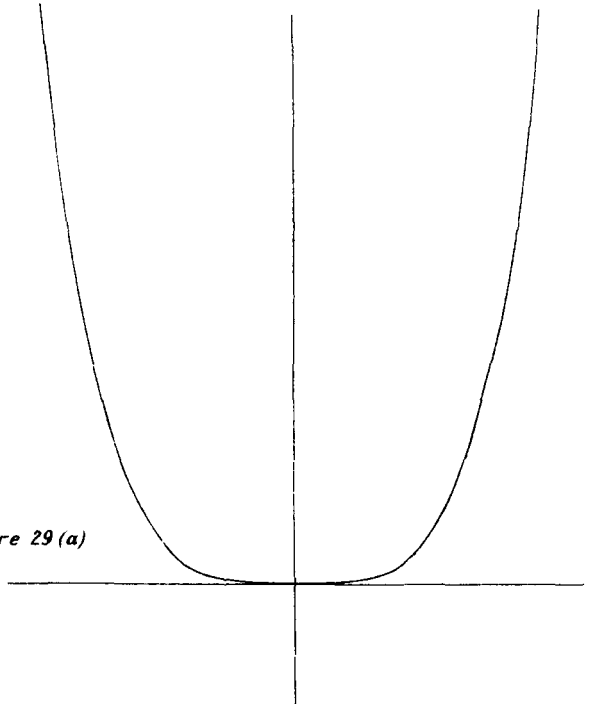
*Figure 28 (a).*



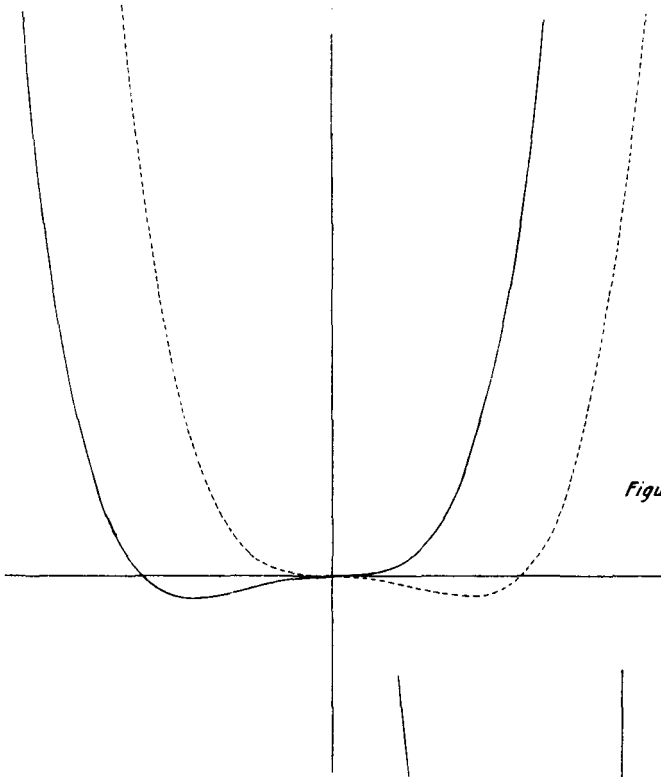
*Figure 28 (b).*



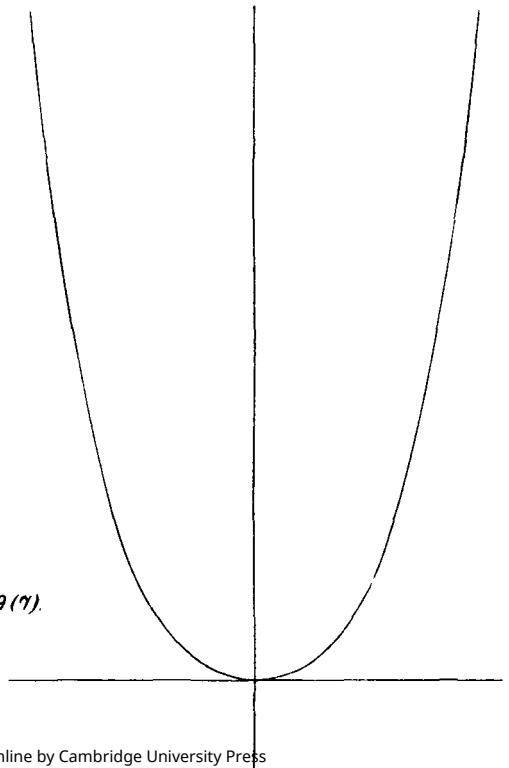
*Figure 28 (c).*



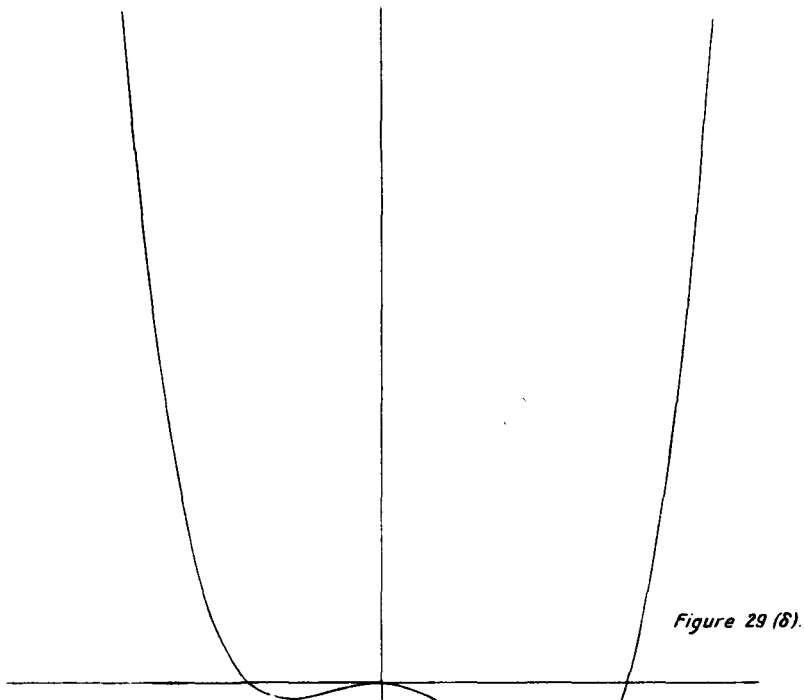
*Figure 29 (a)*



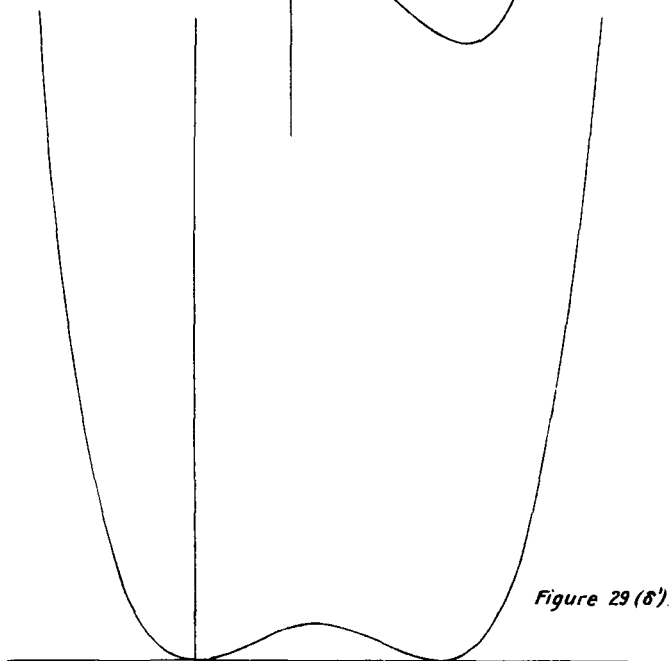
*Figure 29 (β).*



*Figure 29 (γ).*



*Figure 29 ( $\delta$ ).*



*Figure 29 ( $\delta'$ ).*

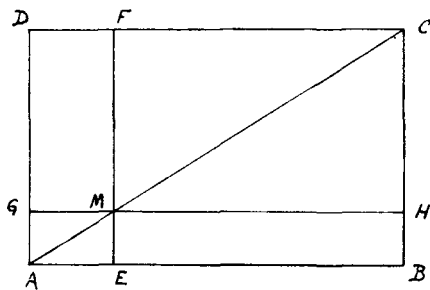


Figure 30

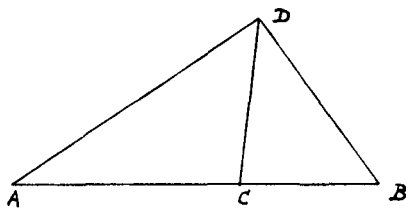


Figure 31



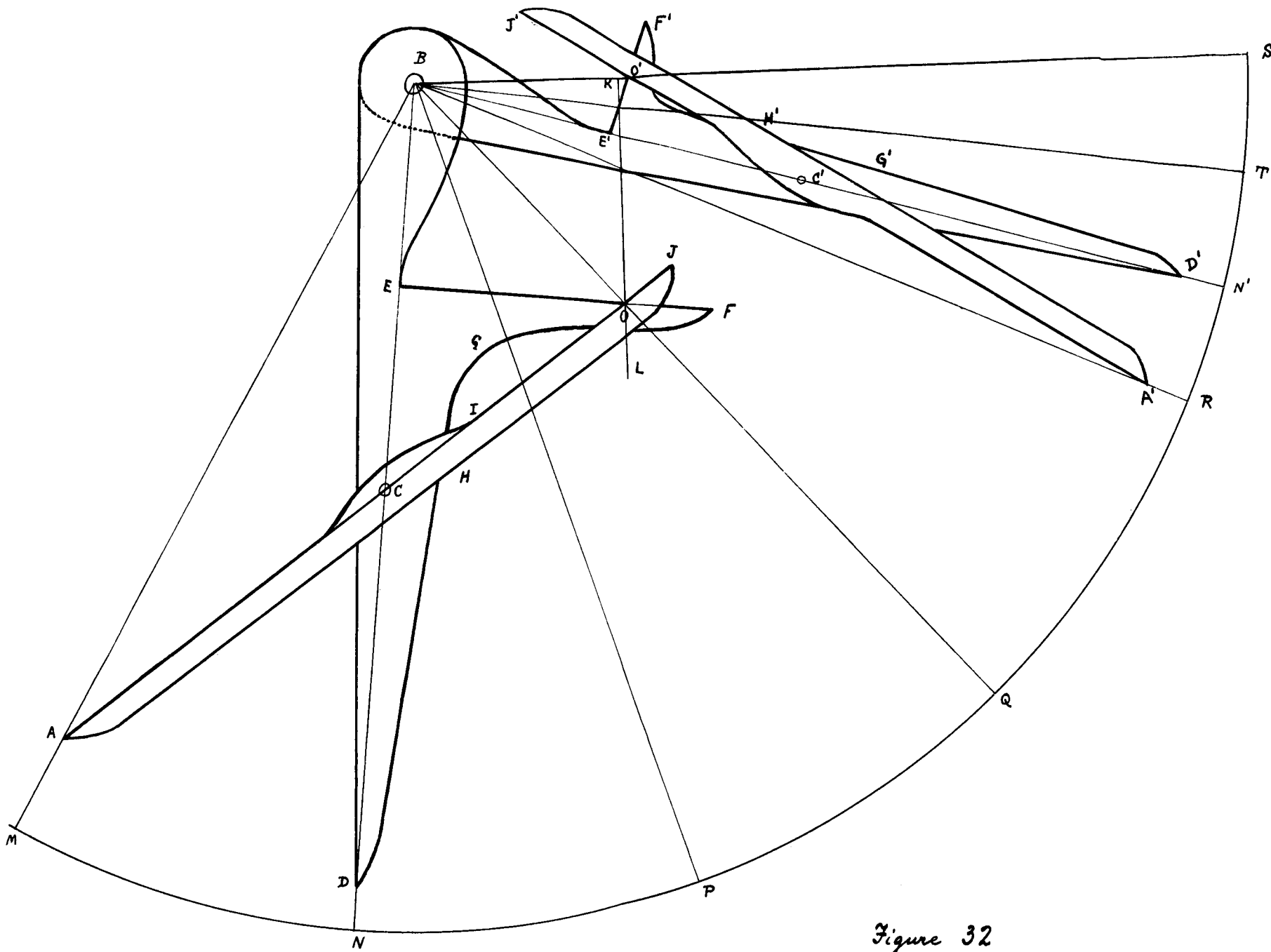


Figure 32

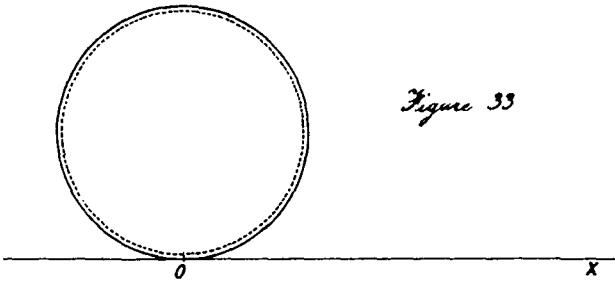


Figure 33

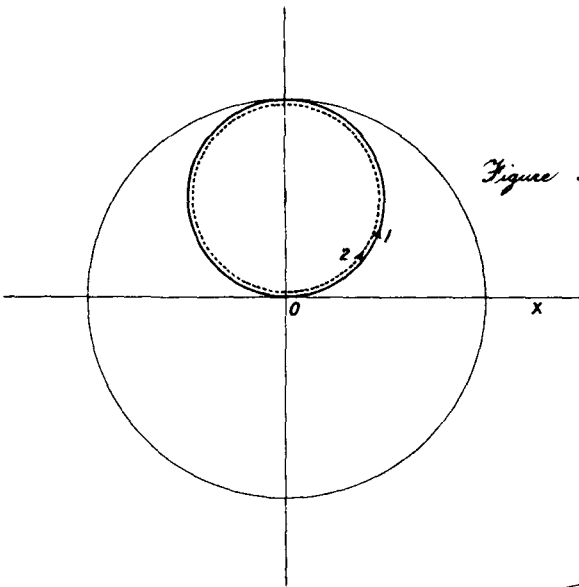


Figure 34

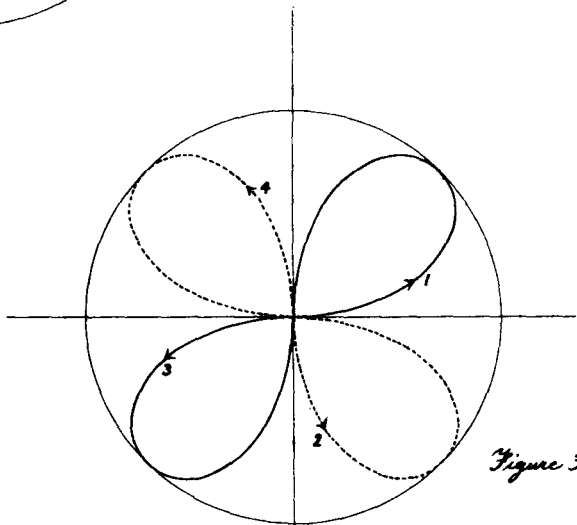
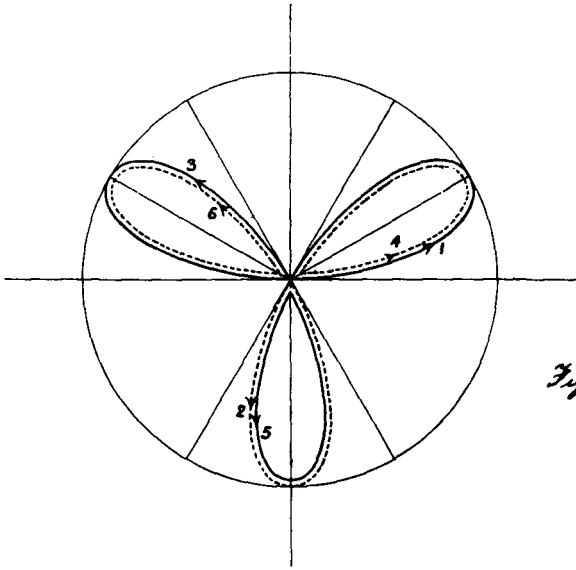
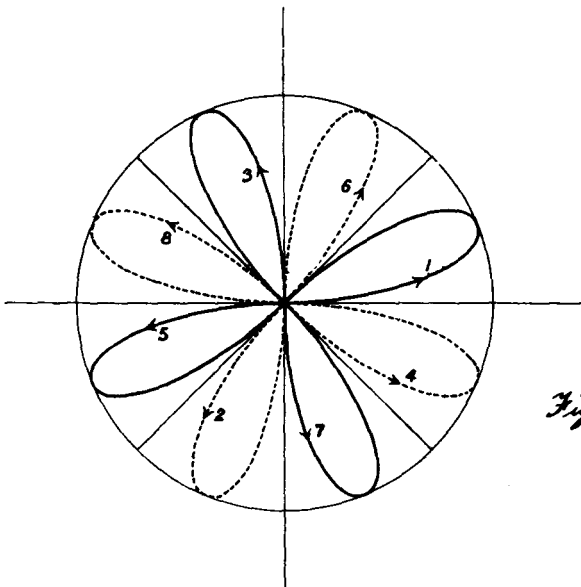


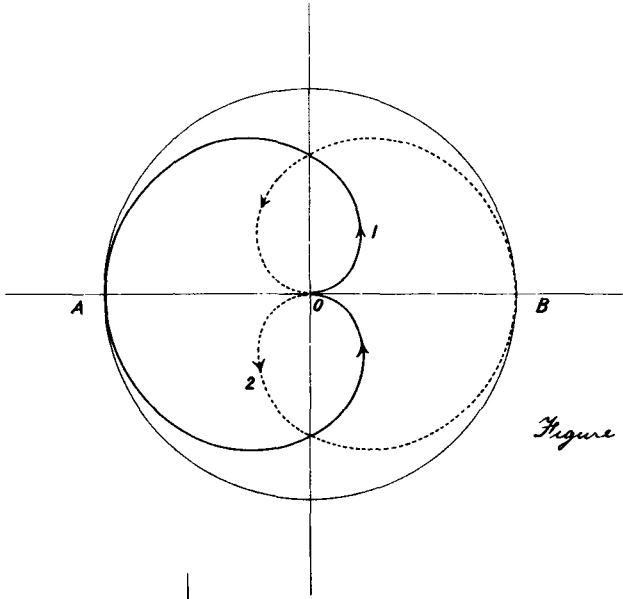
Figure 35



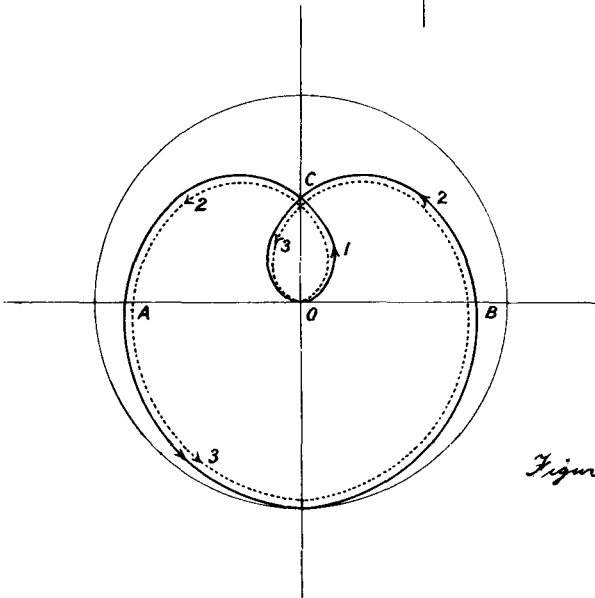
*Figure 36*



*Figure 37*



*Figure 38*



*Figure 39*

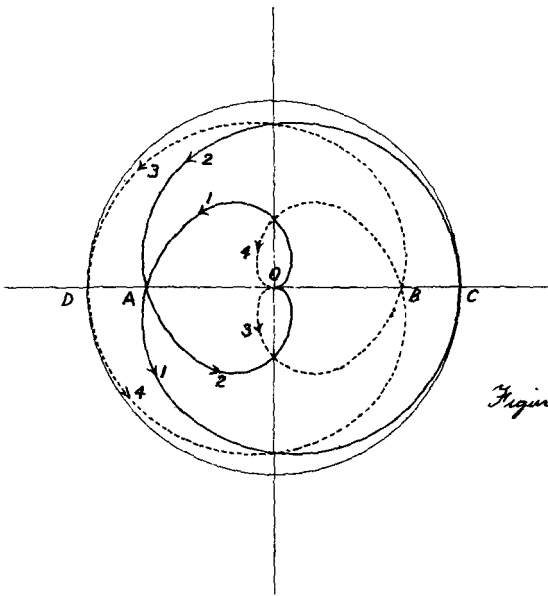


Figure 40.

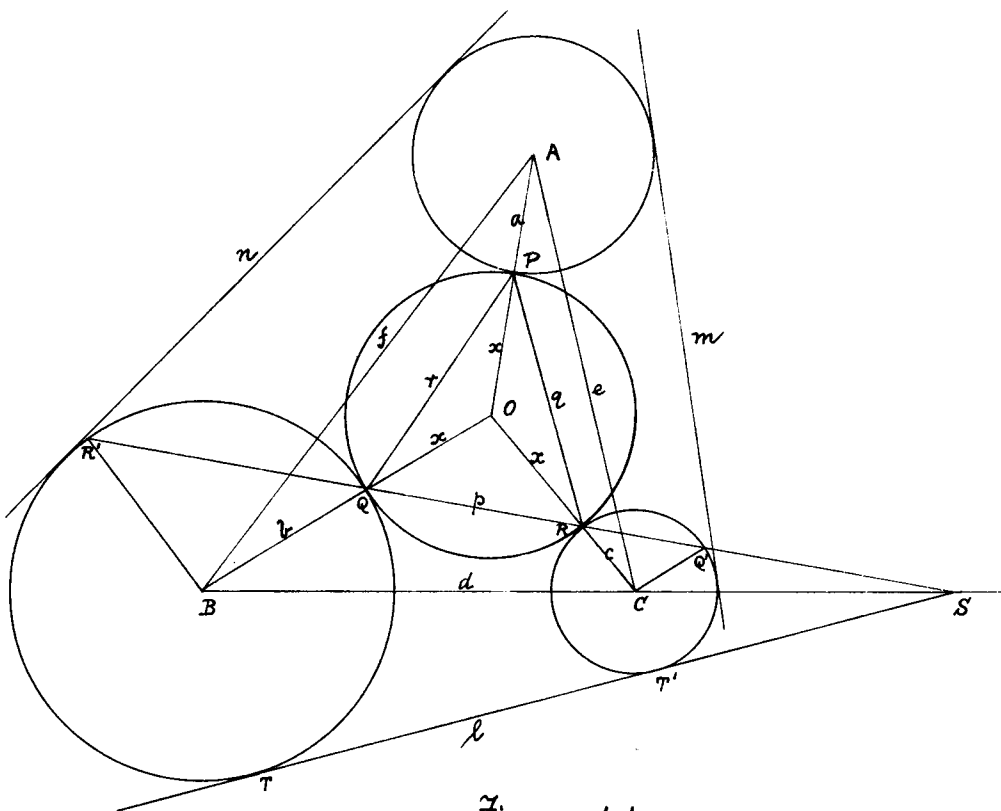


Figure 41

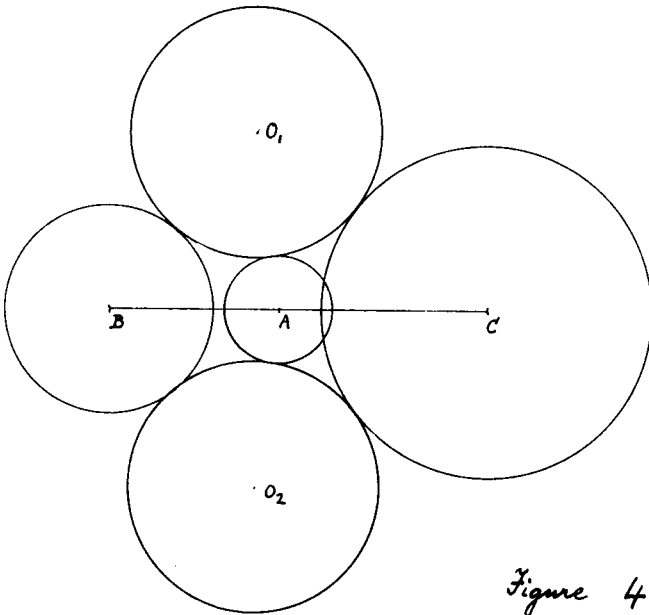


Figure 42

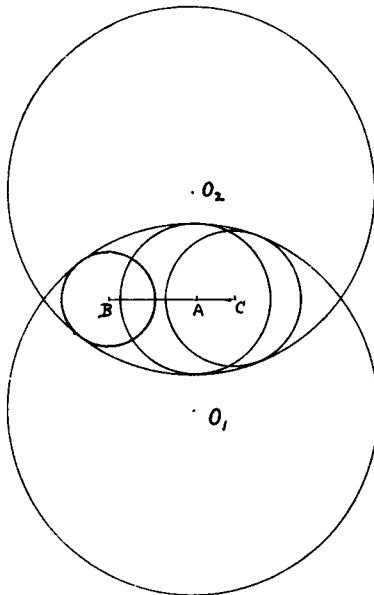


Figure 43