

The Journal of Laryngology and Otology

EDITED BY
WALTER HOWARTH

WITH THE ASSISTANCE OF
V. E. NEGUS AND F. W. WATKYN-THOMAS

Contents

THE LYMPHATIC SYSTEM IN RELATION TO RECURRENT LARYNGEAL NERVE PARALYSIS SECONDARY TO CANCER OF THE BREAST	H. W. SCHWARTZ
SIMPLIFIED METHOD OF DETERMINING PERCENTAGE OF ACTUAL HEARING-POWER IN TUNING-FORK TESTS	SIR JAMES DUNDAS-GRANT
HEARING AIDS AND HEARING TESTS	C. S. HALLPIKE
THE USE OF THE AUDIOMETER	G. P. CROWDEN
CLINICAL RECORDS—	
AN UNUSUAL CASE OF DYSPHAGIA	A. TUMARKIN
ABSCESS OF TONGUE	W. S. SYME
SOCIETIES' PROCEEDINGS—	
ROYAL SOCIETY OF MEDICINE—SECTION OF OTOTOLOGY	
ROYAL SOCIETY OF MEDICINE—SECTION OF LARYNGOLOGY	
ABSTRACTS—	
THE EAR	THE NOSE AND ACCESSORY SINUSES
THE TONSIL AND PHARYNX	ENDOSCOPY
MISCELLANEOUS	
LETTER TO THE EDITOR	GENERAL NOTES

London
Headley Brothers
109 Kingsway, W.C.2

Monthly, 4/- net post free

Annual Subscription, 40/- net

THE UNIVERSAL CAUTERY & LAMP UNIT

FOR ALL ALTERNATING & DIRECT CURRENT CIRCUITS
EARTH FREE PORTABLE



IMMEDIATE CURRENT INDICATION WITH
FACILE ADJUSTMENT TO VOLTAGE ON
A.C. AND D.C.

*COMPLETE and FINE REGULATION of LAMP and CAUTERY OUTPUT
GUARANTEED*

THECO ELECTRICAL APPLIANCES LTD.
MANFRS.

33 THEOBALDS ROAD, LONDON, W.C.1
CHANCERY 7736

ARRANGEMENTS FOR DEMONSTRATIONS IN THE LONDON OR
GREATER LONDON AREAS CAN ALWAYS BE MADE BY PHONE
REQUESTS FOR DEMONSTRATIONS ELSEWHERE ARE ALSO
COURTEOUSLY INVITED & WILL RECEIVE FULL CONSIDERATION

Please mention *The Journal of Laryngology* when replying to advertisements

**DOWN BROS.'
New Bronchoscopic Lamps**

A Shows the usual Howarth or Jackson Lamp which throws a forward shadow from the "pip" at the point.

B Shows the new HOWARTH pipless lamp giving even illumination.
(Foreign bulb. English mounting.)

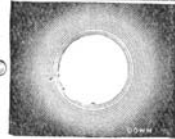
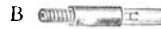
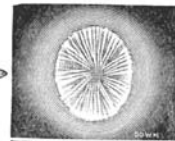

**NEW
PRISM
PANEL
AND
TWIN
ILLUMINATION
GIVING
CLEAN
SURFACE
AND AN
EVEN,
BRIGHT,
SHADOWLESS FIELD
OF
ILLUMINATION**

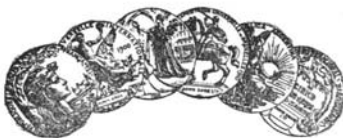
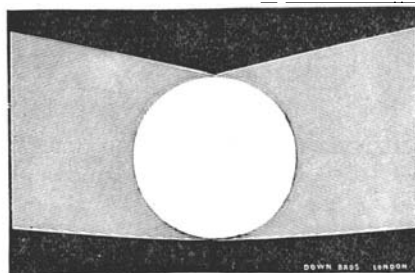
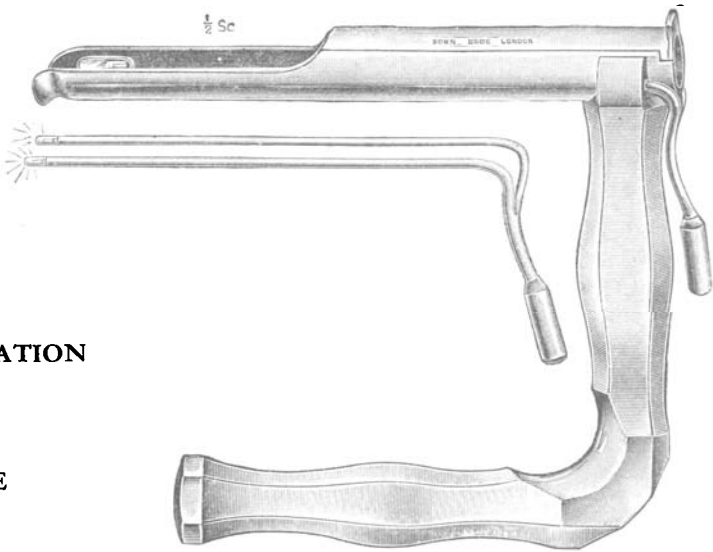

Telegrams—DOWN, LONDON
Telephone—HOP 4400 (4 lines)

Manufactured only by
DOWN BROS. LTD.
Surgical Instrument Makers
21 and 23 ST. THOMAS'S STREET
LONDON, S.E. 1
(Opposite Guy's Hospital)

Please mention *The Journal of Laryngology* when replying to advertisements

DeVilbiss

AEROL ATOMIZER COMBINATION No. 100

Price of Complete Outfit	6/-
2 oz. refills	2/6
1 oz. refills	1/9

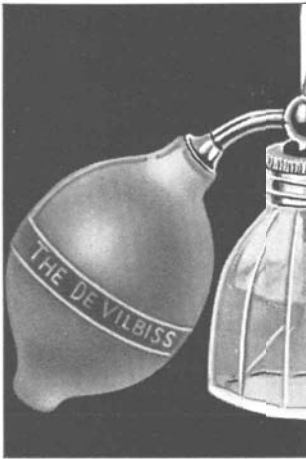

This highly efficient DeVILBISS Outfit meets the demand for a dependable nose and throat Atomizer already filled with an approved solution. It forms a convenient prescription in cases of common colds, influenza, catarrh, sore throats and hay-fever.

The Aerol Compound in this Atomizer contains Camphor-Menthol, Oil Pine Needles, Oil Cinnamon, Oil Thuja Occidentalis, Chlorbutol and Neutral Hydrocarbon Oil.

Obtainable from all chemists or from the Sole Distributors in the United Kingdom.

AEROGRAPH COMPANY LIMITED

43 Holborn Viaduct, London, E.C.1

CV8-68

THE INTRA-NASAL IONIZER

(PATENT NO. 373803)

FOR HAY FEVER AND NON-SUPPURATIVE RHINITIS

For applying current to the nasal tissues for the treatment of Hay Fever and paroxysmal Rhinitis, as described by Mr. Philip Franklin, F.R.C.S., in the *British Medical Journal*, June 27th, 1931. The apparatus consists of positive and negative electrodes, through which is conveyed a galvanic current from the battery as shown in the illustration.

PRICES

Complete outfit as illustrated - £6 18s. 6d.
 Ionizer, Headband, Knee Pad and Flexes, only - £1 8s. 6d.

Full particulars will be sent on application to the manufacturers and patentees

THEODORE HAMBLIN LTD.

15 WIGMORE STREET
 LONDON, W.1



Please mention *The Journal of Laryngology* when replying to advertisements

ROGERS' STANDARD SPRAYS

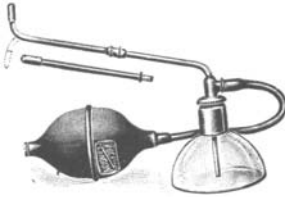

HAVE A
WORLD-WIDE REPUTATION

For Efficiency & Reliability
They are made in many forms, scientifically
designed for
NASAL, PHARYNGEAL, POST-NASAL
and **LARYNGEAL TREATMENT**

*Particulars gladly supplied
on request*

Sole Manufacturer—

FRANK A. ROGERS (LATE OF OXFORD ST.)

1 Beaumont Street, London, W.1

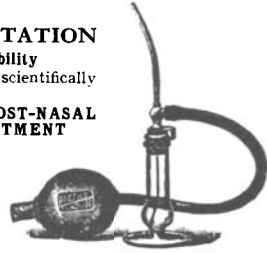

THIRD EDITION.

FULLY REVISED AND ENLARGED.

Demy 8vo, 490 pp. 250 Text Illustrations and 19 plates (of which 8 are in colour). 2os. net, postage 9d.

DISEASES OF THE NOSE, THROAT AND EAR

For Practitioners and Students

Edited by A. LOGAN TURNER, M.D., LL.D., F.R.C.S.E.

Consulting Surgeon, Ear and Throat Department, Royal Infirmary, Edinburgh

With the collaboration of

J. S. FRASER, M.B., F.R.C.S., W. T. GARDINER, M.C., M.B., F.R.C.S., J. D. LITHGOW, M.B., F.R.C.S.,
G. EWART MARTIN, M.B., F.R.C.S., and DOUGLAS GUTHRIE, M.D., F.R.C.S.

"There is no other book which includes laryngology and otology with such success. . . . The present edition should surpass the previous issues in popularity."—*British Medical Journal*.

"The work is an important one, and gives an admirably clear and concise account of diseases of the speciality. . . . The numerous excellent illustrations add to the value of the book."—*The Lancet*.

"The whole work maintains a high standard, and there is little but praise for its clearness and comprehensiveness. . . . The book is perhaps the best of modern text-books dealing with the whole of oto-rhino-laryngology, and is one which experts as well as students will find most useful."—*Jour. of Laryngology and Otology*.

Bristol: John Wright & Sons Ltd. *New Illustrated Catalogue free.* London: Simpkin Marshall Ltd.

BACK NUMBERS OF THE JOURNAL OF LARYNGOLOGY

Back numbers of most issues of this Journal since 1900 can be obtained from Headley Brothers, 109 Kingsway, London, W.C.2. The following, however, are out of print, and no stock is at present available:

1902. February.	1921. January to June.
1914. August.	1924. January to March, July to December.
1920. January and August.	1931. October.

If any subscribers have any of these copies which they do not need, it would be greatly appreciated if they would return them to the Publishers who will refund the full published price.

HEADLEY BROTHERS, 109 KINGSWAY, LONDON, W.C.2

For Advertisement space in this Journal apply to:
HEADLEY BROTHERS, 109 Kingsway, London, W.C.2

Please mention *The Journal of Laryngology* when replying to advertisements

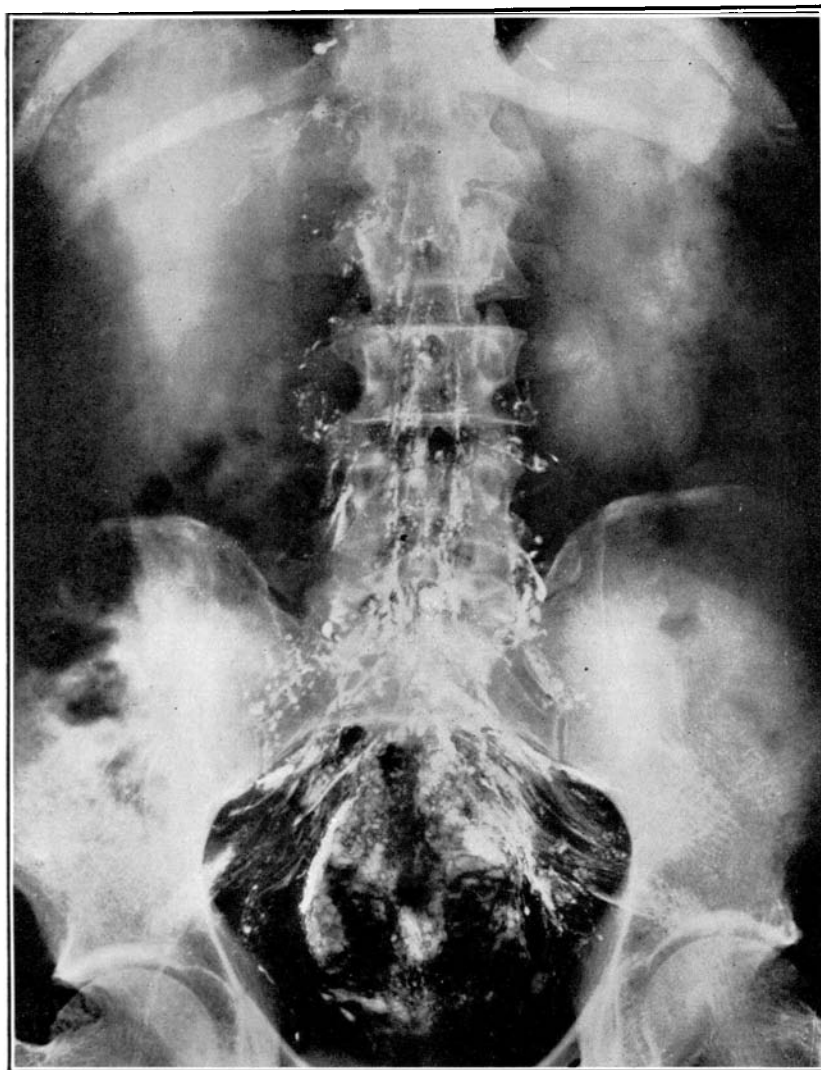

Epidural injection with Lipiodol.



ILFORD X-RAY
FILM
Super Speed Non-Abrasive
Uniform Quality

ILFORD LIMITED, ILFORD, LONDON

Please mention *The Journal of Laryngology* when replying to advertisements

THE GOLDEN SQUARE THROAT, NOSE AND EAR HOSPITAL

Near Piccadilly Circus
LONDON, W.1

HONORARY MEDICAL STAFF

Surgeons

Mr. T. JEFFERSON FAULDER
Mr. LIONEL COLLEDGE
Mr. GILBERT CHUBB

Mr. F. CUNLIFFE ORMEROD
Mr. A. R. DINGLEY
Mr. G. H. HOWELLS

Assistant Surgeons

Mr. S. A. BEARDS
Mr. J. F. SIMPSON

Mr. J. C. HOGG
Mr. M. L. FORMBY

The Hospital now has 101 beds for In-patients and an annual Out-patient attendance of about 60,000.

CLINICAL INSTRUCTION

Clinical Instruction in the Diagnosis and Treatment of Diseases of the Throat, Nose and Ear is given daily in the Out-patient Department from 2 to 5 p.m., and on Tuesdays and Thursdays from 6.30 to 8 p.m. Major operations are performed daily, except Saturdays, in the In-patient Operating Theatres. Minor operations are performed in the Out-patient Department by the Assistant Surgeons on three mornings a week. Special Demonstrations are held in the Out-patient Department each Monday and Wednesday at 3 p.m. Practitioners and Medical Students are admitted to the practice of the Hospital, and Clinical Assistants, whose duty it is to assist the staff, are appointed from time to time among them. For further information apply to the Dean, Mr. F. CUNLIFFE ORMEROD

CENTRAL LONDON THROAT, NOSE AND EAR HOSPITAL GRAY'S INN ROAD

(Near King's Cross Stations)

DAILY CLINICS. LECTURES ON FRIDAYS, 4 p.m.

OVER 11,000 NEW PATIENTS YEARLY. 50,000 ATTENDANCES.

IN-PATIENT DEPARTMENT (Hospital and Recovery Home), 104 BEDS. In-Patient Operations Daily.

SPECIAL INTENSIVE COURSE OF LECTURES AND DEMONSTRATIONS

(including Operative Surgery Course; Anatomy and Physiology Class, Peroral Endoscopy Class and Pathology Class, especially suitable for D.L.O. Students), twice yearly—May and October.

COURSES IN METHODS OF EXAMINATION AND DIAGNOSIS at frequent intervals.

SURGEONS

Mr. HAROLD KISCH

Mr. C. GILL-CAREY

Mr. ARCHER RYLAND

Mr. J. D. McLAGGAN

Mr. F. W. WATKYN-THOMAS

Mr. W. A. MILL

ASSISTANT SURGEONS

Mr. A. LOWNDES YATES, Mr. N. ASHERSON, Mr. W. G. SCOTT-BROWN

CLINICAL ASSISTANTS

Are appointed from among those duly qualified gentlemen who have been enrolled as Post-Graduate Students of the Hospital.

FEES

For attendance on the practice of the Hospital—

Three months 5 guineas | Six months 8 guineas

Special Intensive Course—

Clinical Course, £5 5s., Operative Surgery, £7 7s., Endoscopy, £6 6s., Pathology, £5 5s.

Further particulars on application to

J. D. McLAGGAN, M.A., F.R.C.S., Dean.

JOHN H. YOUNG, Secretary-Superintendent

Please mention *The Journal of Laryngology* when replying to advertisements

Annals of Otolaryngology, Rhinology and Laryngology

The outstanding American quarterly

NOW IN ITS FORTY-THIRD YEAR

World-wide circulation carries the Annals to every corner of Europe, Asia, Africa, South America, and Australia which indicates its appeal and interest.

This journal is devoted entirely to original scientific papers, and case reports, and prints no advertisements. Here is a worth-while addition to your library.

It is edited by a distinguished staff of fifteen headed by L. W. DEAN, M.D., and A. W. PROETZ, M.D.

Subscription { 1 year £1 8s. or \$6·80
 { 2 years £2 8s. or \$11·60

(Your personal cheque will suffice)

ANNALS PUBLISHING CO.

7200 WYDOWN BLVD., ST. LOUIS, MO., U.S.A.

or

H. K. LEWIS & CO., LTD.

136 GOWER STREET, LONDON, W.C.1

or

YOUR OWN DEALER

Please mention *The Journal of Laryngology* when replying to advertisements

With 199 Illustrations (5 coloured). Demy 8vo. 25s. net. Postage 9d.

THE PRINCIPLES AND PRACTICE OF OTOLOGY

By

F. W. WATKYN-THOMAS, F.R.C.S., and **A. LOWNDES YATES**, M.C., M.D.,
B.Ch.Camb., Surgeon, Central London Throat, Nose and Ear Hospital, etc. F.R.C.S., Hon. Assistant Surgeon, Central London Throat, Nose and Ear Hospital, etc.

"... a new book and a modern book... a tribute to the knowledge and energy of the authors... no otologist can afford to leave this work unread."—JOURNAL OF LARYNGOLOGY AND OTOLOGY.

"... contains a most valuable account of recent research in otology and provides a rich and abundant feast for the thoughtful."—BRITISH MEDICAL JOURNAL.

London: H. K. LEWIS & CO. LTD., 136 Gower Street, W.C.1

AIDS FOR THE DEAF

The MARCONI PHONE OTOPHONE

THE OUTCOME OF RADIO RESEARCH FOR THE DEAF

All patients are allowed seven days independent home trial

Full particulars "F" on request

Sole Distributors for Gt. Britain & N. Ireland **T. HAWKSLEY LTD.** Specialists, since 1869, in Aids for the Deaf

Note New Address: 10-12 JAMES ST., OXFORD ST., LONDON, W.1

Nearly opposite Bond Street Tube Station

Phone: MAYFAIR 1182

INDEX

to the Journal of Laryngology & Otology

VOLUMES XXXVI—XLV

1921—1930

INVALUABLE FOR REFERENCE

Copies are now available and will be sent on receipt of remittance, value Ten Shillings.

Also back numbers as far as available from the commencement of the Journal in 1887, may be obtained from the Publishers

HEADLEY BROTHERS, 109 KINGSWAY, LONDON, W.C.2

For Advertisement space in this Journal apply to:

HEADLEY BROTHERS, 109 Kingsway, London, W.C.2

Please mention *The Journal of Laryngology* when replying to advertisements

The Journal of Laryngology and Otology

(Founded in 1887 by MORELL MACKENZIE and NORRIS WOLFENDEN)

EDITED BY

WALTER HOWARTH

ASSISTED BY

V. E. NEGUS AND F. W. WATKYN-THOMAS

1. Original Articles are accepted on the condition that they have not been published elsewhere.
2. Manuscripts should be typewritten, on one side only of the paper, and well spaced.
3. Galley proofs and engraver's proofs of illustrations are sent to the author. Corrections, which should be kept to a minimum, must be clearly marked and no additional matter added.
4. Orders for reprints should be sent when returning galley proofs, and for this purpose special forms are supplied, on which the price of the reprints is stated.
5. Authors of Original Communications on Oto-Laryngology in other Journals are invited to send a copy, or two reprints, to the *Journal of Laryngology*. If they are willing, at the same time, to submit their own abstract (in English, French, Italian, or German) it will be welcomed.
6. Editorial Communications may be addressed to THE EDITOR, *Journal of Laryngology*, c/o HEADLEY BROTHERS, 109 Kingsway, London, W.C.2.
7. The Annual Subscription commencing with the January issue is Forty Shillings, post free, and is payable in advance.
8. Single copies, both of the present and the previous series, are on sale at Four Shillings each.
9. All Subscriptions, advertising and business communications should be sent to the Publishers, HEADLEY BROTHERS, 109 Kingsway, London, W.C.2.

United States of America

Orders for this Journal, for single parts or yearly subscriptions, may be sent either through a local bookseller, or to Messrs. G. E. STECHERT & Co., 31-33 East 10th Street, New York.

Please mention *The Journal of Laryngology* when replying to advertisements

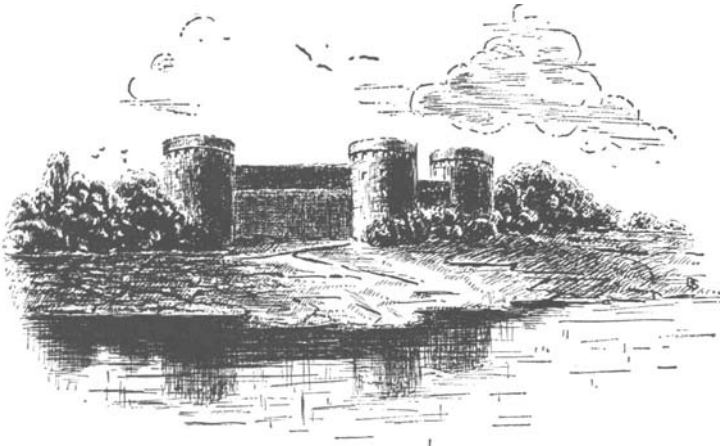

A Stronghold

IN THE TREATMENT of the Pneumonias, in order to lessen toxæmia and to reinforce the patient's power of resistance, the use of Antiphlogistine Dressing serves as an appropriate adjunct.

Its symptomatic effects are manifested by

- Early relief from pain
- Improved heart action
- Relief of dyspnœa
- General soothing of the patient with induction of sleep.

Antiphlogistine Brand Dressing often proves a stronghold when other methods fail.

R

Antiphlogistine
BRAND TRADE MARK DRESSING

for Pneumonia

MADE IN ENGLAND

Sample and literature on request

THE DENVER CHEMICAL MANUFACTURING CO.
LONDON, E. 3

Please mention *The Journal of Laryngology* when replying to advertisements

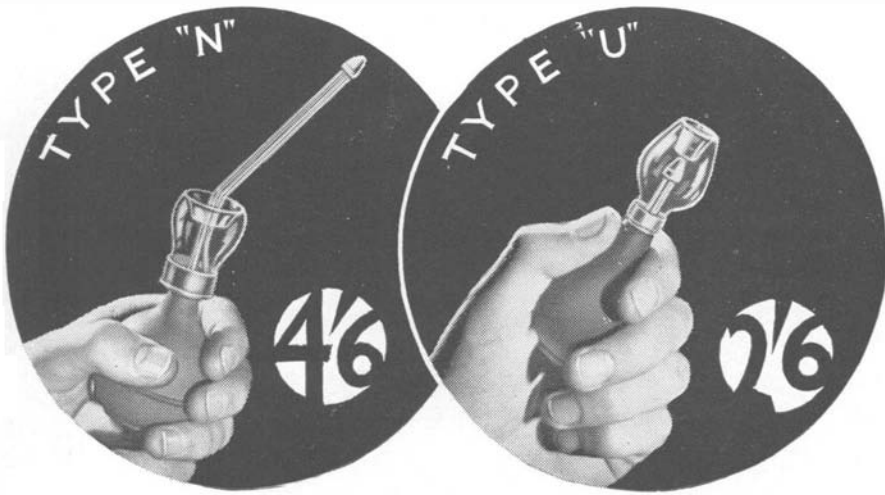

The
“MILLETT” ATOMISER
 BRITISH MADE

In introducing our product we suggested that—“the advantages of the Millett Atomiser are so evident, so obviously necessary that one wonders why they have not been adopted before.”

Sales have proved that we were correct. The Millett Atomiser does fulfil a demand.

Millett Atomisers require only one hand for use, the contents will not spill in any position.

The fluid is carried in a liberal glass bulb, and any type of liquid is perfectly atomised. All metal parts are chromium plated, and only the best rubber and glass is used. You cannot obtain a better atomiser at any price.

Model “N” for throat and nose use. Easily sterilised by removing the glass vessel from the base.

Model “U” for general and nasal use.

It is only necessary to put the exact dose into the atomiser.

- OBTAINABLE FROM ALL HIGH-CLASS CHEMISTS INCLUDING
BOOTS THE CHEMISTS

Atomisers
LIMITED

Proprietors of the “Millett” Atomiser Patents Makers of fine Sprayers and Atomisers

13 GREAT PULTENEY STREET, LONDON, W.1

Telephone Gerrard 1054

Please mention *The Journal of Laryngology* when replying to advertisements

CONTENTS

	PAGE
THE LYMPHATIC SYSTEM IN RELATION TO RECURRENT LARYNGEAL NERVE PARALYSIS SECONDARY TO CANCER OF THE BREAST. H. W. Schwartz, Halifax, Canada	221
SIMPLIFIED METHOD OF DETERMINING PERCENTAGE OF ACTUAL HEARING-POWER IN TUNING-FORK TESTS. Sir James Dundas-Grant, London	233
HEARING AIDS AND HEARING TESTS. C. S. Hallpike, London	240
THE USE OF THE AUDIOMETER. G. P. Crowden, London	247
CLINICAL RECORDS—	
An Unusual Case of Dysphagia. A. Tumarkin, Liverpool	264
Abscess of Tongue. W. S. Syme, Glasgow	267
SOCIETIES' PROCEEDINGS—	
Royal Society of Medicine—Section of Otology	268
Royal Society of Medicine—Section of Laryngology	274
ABSTRACTS—	
The Ear	283
The Tonsil and Pharynx	289
The Nose and Accessory Sinuses	290
Endoscopy	293
Miscellaneous	294
LETTER TO THE EDITOR	296
GENERAL NOTES	296